

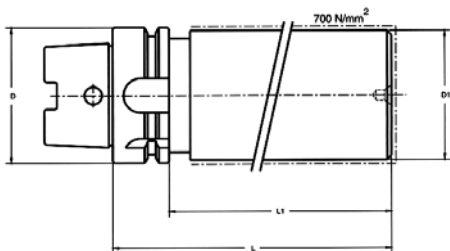

## PORTAHERRAMIENTAS SEMIACABADOS



Ref.	Código	D HSK-A	D1	L	L1
2106800	01914530402	40	40	100	80
2106801	01914530403	50	50	100	74
2106802	01914530502	50	63	160	134
2106803	01914530503	63	63	100	74
2106804	01914530602	63	80	160	134
2106805	01914530603	80	80	160	134
2106806	01914530604	100	100	160	131

## PINZAS

### PINZAS PARA PORTAPINZAS DIN 6388

Sujeción de mangos cilíndricos lisos

Forma A

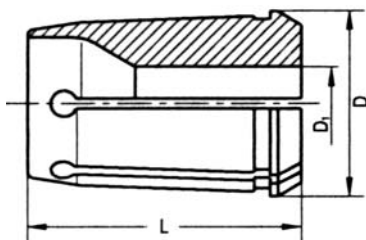

Ref.	Código	D	L	D1	Campo
2106900	0020101	11,5	21	1 2/3-4-5-6	-0,5
2106901	0020102	17,2	30	2 3-4-5-6-7-8-9-10	-0,5
2106902	0020103	25,5	40	2 3-4-5-6-7-8-9-10-11-12-13-14-15-16	-0,5
2106903	0020104	29,8	45	2 3-4-5-6-7-8-9-10-11-12-13-14-15-16	-0,5
2106904	0020105	35,05	52	2 3-4-5-6-7-8-9-10	-0,5
2106905	0020106	43,7	60	4 5-6-7-8-9-10	-0,5
2106906	0020107	52,5	68	4 5-6-7-8-9-10-11-12-13-14-15	-0,5

### PINZAS PARA PORTAPINZAS DIN 6388

Sujeción de mangos cilíndricos lisos

Forma B

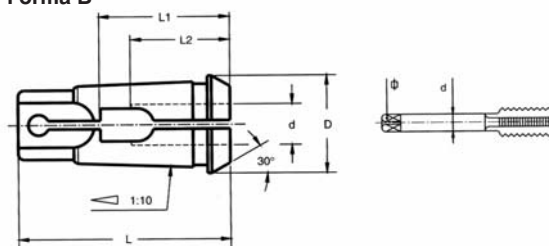

Ref.	Código	D	L	D1	Campo
2107000	0020403	25,5	40	5-55 6-65-7-75-8-85	-0,5
2107001	0020404	29,8	45	6-65-7-75-8-85 9-95-10-105-11-115	-0,5
2107002	0020405	35,05	52	6-65-7-75-8-85-9-95 10-105-11-115	-0,5
2107003	0020406	43,7	60	6-65-7-75-8-85-9-95 10-105-11-115	-0,5

### PINZAS PARA PORTAMACHOS

Sujeción de mangos cilíndricos DIN 10

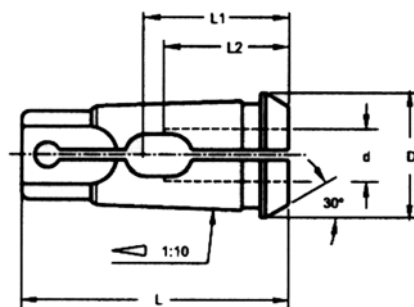

Ref.	Código	CAP.	D	L
2107100	0021903	M3-M16	25,4	52
2107101	0021904	M8-M28	29,8	63

Material: Acero de muelles Templado  
Dureza: Rc 57 + 60 HRC





**PINZAS DIN 6499 (TIPO ER)**

Sujeción de mangos cilíndricos lisos

Forma B

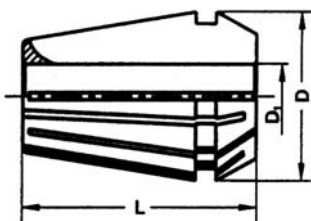

Ref.	Código	ER	D	L	D1	Campo
2107200	0021101	ER-8	8,5	13,5	1-1,5-2-2,5	-0,5
2107201	0021102	ER-11	11,5	18	1-1,5-2-2,5	-0,5
2107202	0021103	ER-16	17	27	1 2-3-4-5-6	-1
2107203	0021104	ER-20	21	31	2-3-4-5-6	-1
2107204	0021105	ER-25	26	35	2-3-4-5-6	-1
2107205	0021106	ER-32	33	40	2-3-4-5-6	-1
2107206	0021107	ER-40	41	46	4-5-6-7-8-9-10	-1
2107207	0021108	ER-50	52	60	12-14-16-18-20	-2

**PINZA ER PARA MACHOS**

Sujeción de mangos cilíndricos lisos con cuadradillo

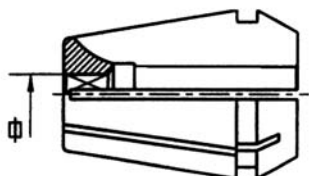

Ref.	Código	ER	D	L	D1	Campo
2107300	0021403	ER-16	17	27	3,5-4-4,5-5-5,5-6-7	-
2107301	0021405	ER-25	25	35	3,5-4-4,5-5-5,5-6-7-8-9-10-11-12	-
2107302	0021406	ER-32	33	40	4,5-5-5,5-7-7-8-9-10-11-12-14-16	-
2107303	0021407	ER-40	41	46	6-7-8-9-10-11-12-14-16-18-20	-
2107304	0021408	ER-50	52	60	8-9-10-11-12-14-16-18-20-32	-

**HERMÉTICA 100% ACERO**

Para herramientas de mango cilíndrico liso con paso de refrigeración

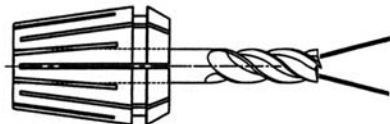

Ref.	Código	ER	D	L	D1	Campo
2107400	0021503	ER-16	17	27	3-4-5 6-7-8-9-10	- -0,5
2107401	0021505	ER-25	26	35	3-4-5 6-7-8-9-10-11-12-13-14-15-16	- -0,5
2107402	0021506	ER-32	33	40	3-4-5-6 7-8-9-10-11-12-13-14-15-16-18-20	- -0,5
2107403	0021507	ER-40	41	46	4-5-6-7-8 9-10-11-12-13-14-15-16-18-20-25	- -0,5

**HERMÉTICA 100% ACERO**

Para herramientas de mango cilíndrico liso sin paso de refrigeración

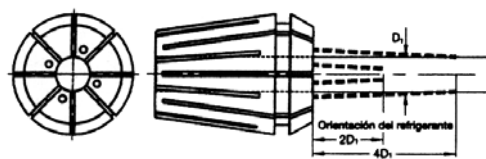

Ref.	Código	ER	D	L	D1	Campo
2107500	0021603	ER-16	17	27	3-4 5-6-7-8-9-10	- -0,5
2107501	0021605	ER-25	26	35	3-4-5 6-7-8-9-10-11-12-13-14-15-16	- -0,5
2107502	0021606	ER-32	33	40	3-4-5-6 7-8-9-10-11-12-13-14-15-16-17-18-19-20	- -0,5
2107503	0021607	ER-40	41	46	4-5-6-7-8 9-10-11-12-13	- -0,5

**PROLONGADORES DE CONTRACCIÓN TÉRMICA**

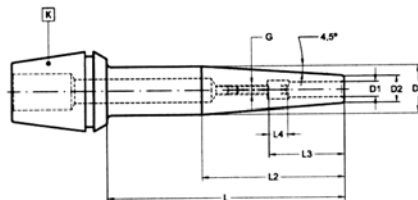

Desviación circular entre K y D ≤ 0,003

Ref.	Código	D HSK-A	Tamaño	D1	L	D2	G
2107600	01262121603	40	(ER25)	1-16	80	42	M-10
2107601	01262121604	40	(ER25)	2-20	100	50	M-16
2107602	01262121605	50	(ER25)	1-16	80	42	M-10
2107603	01262121606	50	(ER25)	2-20	100	50	M-16
2107604	01262127606	63	(ER25)	1-16	80	42	M-10
2107605	01262127606	63	(ER25)	2-20	100	50	M-16
2107606	01262121608	63	(ER25)	3-26	120	63	M-16
2107607	01262121610	80	(ER25)	2-20	100	50	M-16
2107608	01262127610	80	(ER25)	3-26	120	63	M-16
2107609	01262121612	100	(ER25)	2-20	100	50	M-16
2107610	01262127612	100	(ER25)	3-26	120	63	M-16

**PINZAS PARA PORTAPINZAS GRAN APRIETE**

Sujeción de mangos cilíndricos lisos

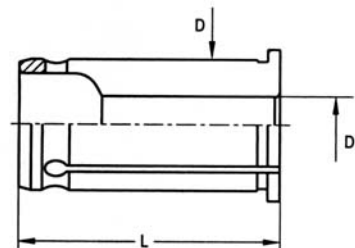

Ref.	Código	D	L	D1
2107700	0020504	20	52,5	6-8-10-12-14-16
2107701	0020506	32	64,5	6-8-10-12-14-16-18-20-25



**PINZAS PARA PORTAPINZAS GRAN APRIETE**

Sujeción de mangos cilíndricos lisos con regulación axial de herramienta

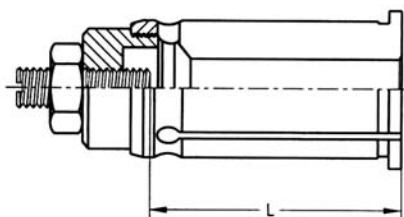

Ref.	Código	D	L	D1
2107800	0020704	20	52,5	6-8-10-12-14-16
2107801	0020706	32	64,5	6-8-10-12-14-16-18-20-25

**ADAPTADORES PORTAMACHOS DE CAMBIO RÁPIDO**

Sin embrague y trabajos de poco esfuerzo

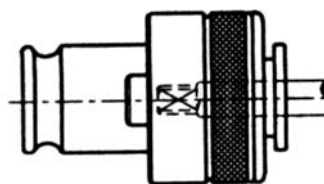

Ref.	Código	D	L	D1
2108100	0022202	19	4	12
2108101	0022203	31	5	20-22
2108102	0022204	48	6	32-36

**PINZAS PARA PORTAPINZAS GRAN APRIETE**

Sujeción de mangos cilíndricos lisos con regulación axial de herramienta y paso de refrigeración

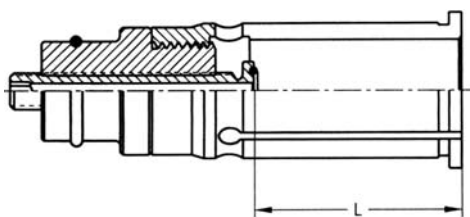

Ref.	Código	D	L	D1
2107900	0020904	20	46	6-8-10-12-16
2107901	0020906	32	58	6-8-10-12-16-20-25

**ADAPTADORES PORTAMACHOS DE CAMBIO RÁPIDO**

Con embrague

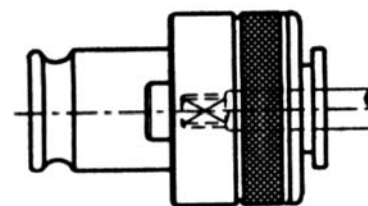

Ref.	Código	D	L	D1
2108200	0022301	21	21	2,5-2,8-3,15-3,5-3,55-4,4-5-5-5,5-5,6-6-6,3-7-7,1-8
2108201	0022302	25	25	3,15-3,5-3,55-4-4,5-5-5,5-5,6-6-6,3-7-7,1-8-9-10-11-11,2
2108202	0022303	34	34	6-6,3-7-7,1-8-9-10-11-11,2-12-12,5-14-16-18
2108203	0022304	45	45	11-11,2-12-12,5-14-16-18-20-22-25-28

**ADAPTADORES PORTAMACHOS DE CAMBIO RÁPIDO**

Sin embrague

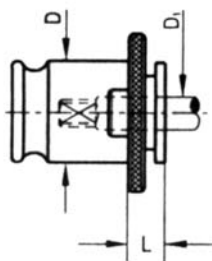

Ref.	Código	D	L	D1
2108000	0022101	13	7	2,5-2,8-3,15-3,5-3,55-4,4-5-5-5,5-5,6-6-6,3-7-7,1-8
2108001	0022102	19	7	3,15-3,5-3,55-4,4-5-5-5,5-5,6-6-6,3-7-7,1-8-9-10-11-11,2
2108002	0022103	31	11	6-6,3-7-7,1-8-9-10-11-11,2-12-12,5-14-16-18
2108003	0022104	48	14	11-11,2-12-12,5-14-16-18-20-22-25-28

**ADAPTADORES PORTAMACHOS DE CAMBIO RÁPIDO**

Con embrague y trabajos de poco esfuerzo

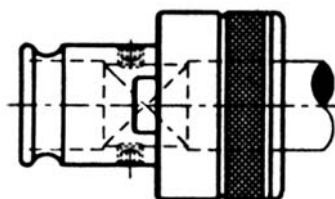

Ref.	Código	D	L	D1
2108300	0022402	19	32	12
2108301	0022403	31	31	20-22
2108302	0022404	48	41	32-36