

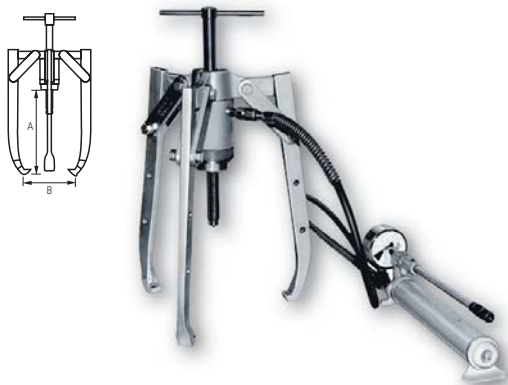

EXTRACTORES

SERIE 1300 TH



Ref.	Código	A	B
1245200	1310 TH	296	350
1245201	1318 TH	320	480
1245202	1330 TH	407	580
1245203	1352 TH	727	920

SERIE 1000



Ref.	Código	A	B máx.	B mín.
1245400	1002	80	80	15
1245401	1002 L	135	80	15
1245402	1003	80	125	15
1245403	1003 L	135	125	15
1245404	1010	160	150	25
1245405	1010 L	220	145	25
1245406	1010 A	160	195	30
1245407	1015	220	195	60
1245408	1020	260	250	105
1245409	1020 A	260	380	30

SERIE 1300 THA AUTOCENTRANTES

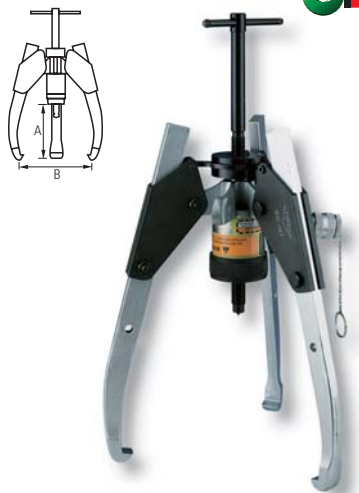

Ref.	Código	A	B
1245300	1310 THA	296	350
1245301	1318 THA	320	480
1245302	1330 THA	407	580
1245303	1352 THA	727	920

SERIE 1100



Ref.	Código	A	B máx.	B mín.
1245500	1102	120	110	47
1245501	1103	120	140	47
1245502	1110	190	195	62
1245503	1120	255	325	105
1245504	1125	255	350	138
1245505	1128	255	445	173
1245506	1135	480	450	177
1245507	1150	680	580	220





SERIE 1200



FORZA

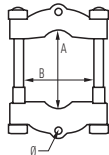

Ref.	Código	B	A máx.	A mín.
1245600	1202 A	60	55	4
1245601	1203 A	80	80	5
1245602	1204 B	110	110	10
1245603	1206 B	152	134	11
1245604	1208 B	180	210	13
1245605	1208 C	180	210	13
1245606	1210 C	260	250	15
1245607	1210 D	260	250	15
1245608	1212 D	300	300	20
1245609	1213 D	330	330	20

1100 / 1200 - EXTRACTORES MECÁNICOS



FORZA

Ref.	Código	A	C	B mín.
1245700	1102-1202 A	100	90	5
1245701	1103-1203 A	100	120	7
1245702	1110-1204 B	170	170	10
1245703	1110-1206 B	170	230	10
1245704	1120-1206 B	200	230	10
1245705	1125-1208 B	200	285	15
1245706	1135-1208 C	410	285	15
1245707	1135-1210 C	410	365	15
1245708	1150-1210 D	610	365	15
1245709	1150-1212 D	610	440	20
1245710	1150-1213 D	610	515	25

1300 - EXTRACTORES MECÁNICOS



FORZA

Ref.	Código	A	B
1245800	1300	55	70
1245801	1301	85	100
1245802	1304	135	150
1245803	1307	180	200
1245804	1310	300	310
1245805	1317	365	425
1245806	1330	460	520

1300 - L EXTRACTORES MECÁNICOS



FORZA

Ref.	Código	A	B
1245900	1301 L	105	110
1245901	1304 L	185	175
1245902	1307 L	225	240
1245903	1310 L	385	360
1245904	1317 L	480	480
1245905	1330 L	585	580

1300 - T EXTRACTORES MECÁNICOS

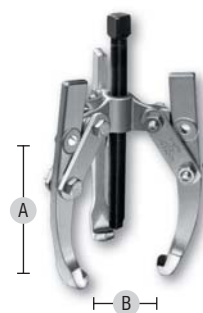

FORZA

Ref.	Código	A	B	Combina 2/3 patas
1246000	1300 T	55	70	no
1246001	1301 T	85	100	si
1246002	1304 T	135	150	si
1246003	1307 T	180	200	si
1246004	1310 T	300	310	si
1246005	1317 T	365	425	no
1246006	1330 T	460	520	no

1300 - LT EXTRACTORES MECÁNICOS

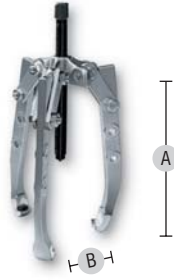

FORZA

Ref.	Código	A	B	Combina 2/3 patas
1246100	1301 LT	105	110	si
1246101	1304 LT	185	175	si
1246102	1307 LT	225	240	si
1246103	1310 LT	385	360	si
1246104	1317 LT	480	480	no
1246105	1330 LT	585	580	no

1400 - EXTRACTORES MECÁNICOS



FORZA

Ref.	Código	A	B
1246200	1401	65	80
1246201	1404	85	150
1246202	1407	125	200
1246203	1410	260	320

1400 - T EXTRACTORES MECÁNICOS



FORZA

Ref.	Código	A	B	Combina 2/3 patas
1246300	1401 T	65	80	si
1246301	1404 T	85	150	si
1246302	1407 T	125	200	si
1246303	1410 T	260	320	si

1500 - EXTRACTORES MECÁNICOS



FORZA

Ref.	Código	A	B máx.	B mín.	Combina con
1246400	1506	110	90	25	1110-1120
1246401	1507	140	90	25	1110-1120
1246402	1509	145	190	50	1120-1135

1500 - A EXTRACTORES MECÁNICOS



FORZA

Ref.	Código	A	B	B mín.
1246500	1506 A	110	90	25
1246501	1507 A	140	90	25
1246502	1509 A	145	190	50

1600 - EXTRACTORES MECÁNICOS

FORZA



Ref.	Código	Rodamientos que extraen	GARRA
1246600	1600-1	6000, 6001, 6002, 6003,	160011
		6200, 6004, 6005, 6006,	160012
		6201, 6202, 6203, 6300	160013
		6204, 6205, 6301, 6302,	160021
		6303	160022
1246601	1600-2	6007, 6008, 6009, 6010	160031
		6011, 6012, 6206, 6207,	160032
		6304, 6305, 6306	
1246602	1600-3	6208, 6209, 6210, 6307,	todas
		6403, 6211, 6212, 6308,	
		6309, 6310, 6311, 6404,	
		6405, 6406	
1246603	1600-A	Todos los rodamientos anteriores	

SERIE 1750

FORZA



Ref.	Código	A	B	a
1246700	1750 C	110	140	2
1246701	1750	150	140	2
1246702	1750 L	200	140	2
1246703	1760	200	210	3,5
1246704	1760 L	300	210	3,5

1800 - EXTRACTORES MECÁNICOS

FORZA

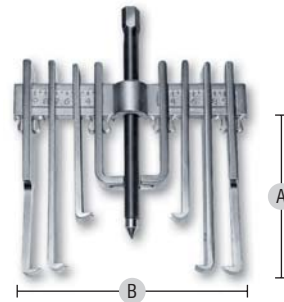

Ref.	Código	A	B
1246800	1805	140	173
1246801	1810	182	250



1800 - T EXTRACTORES MECÁNICOS

FORZA

Ref.	Código	A	B
1246900	1805 T	140	173
1246901	1810 T	182	250

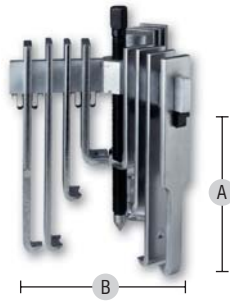

9000 - T EXTRACTORES MECÁNICOS

FORZA



Ref.	Código	A	B
1247200	9002 T	80	80
1247201	9002 LT	130	80
1247202	9002 AT	80	130
1247203	9002 LAT	130	130
1247204	9010 T	160	160
1247205	9010 LT	210	160
1247206	9010 AT	160	210
1247207	9010 LAT	210	210

2400 - EXTRACTORES MECÁNICOS

FORZA



Ref.	Código	A	B
1247000	2410	100	80
1247001	2415	100	130
1247002	2420	150	160
1247003	2425	150	200
1247004	2430	200	250
1247005	2435	200	350
1247006	2440	200	520
1247007	2450	225	640

SERIE 2640

FORZA

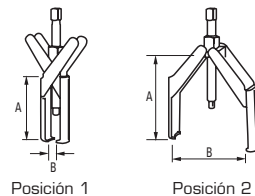

Ref.	Código	POSICIÓN 1		POSICIÓN 2		
		A	B	A	B	
1247300	2641	90	55	90	95	0,3
1247301	2642	125	70	120	125	0,8
1247302	2643	125	80	160	125	1,0

2400 - L EXTRACTORES MECÁNICOS (PATA LARGA)

FORZA

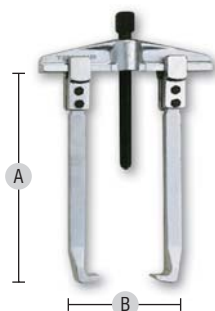

Ref.	Código	A	B
1247100	2410 L	200	80
1247101	2415 L	200	130
1247102	2420 L	300	160
1247103	2425 L	300	200
1247104	2430 L	375	250
1247105	2435 L	375	350
1247106	2440 L	375	520



EXTRACTORES DE INTERIORES
PINZA COMPLETA



Ref.	Código	Ø Medida	Balanza	Ref. componentes		
				Pinza	Cazoleta	Husillo
1247400	4305	5 a 7	0,26	250005	NO	430507
1247401	4308	8 a 11	0,26	251005		430807
1247402	4312	12 a 14	0,26	431205		431207
1247403	4315	15 a 19	0,26	431505		
1247404	4320	20 a 24	0,30	432005		
1247405	4325	25 a 29	0,35	432505		
1247406	4330	30 a 37	0,41	433005	431201	432007
1247407	4338	38 a 46	0,42	433805		
1247408	4347	47 a 54	1,30	434705		
1247409	4355	55 a 64	1,53	435505	434701	434707
1247410	4365	65 a 76	1,95	436505		

Ref.	Código pinza	Medida
1247500	250005	5 a 7
1247501	251005	8 a 11
1247502	431205	12 a 14
1247503	431505	15 a 19
1247504	432005	20 a 24
1247505	432505	25 a 29
1247506	433005	30 a 37
1247507	433805	38 a 46
1247508	434705	47 a 54
1247509	435505	55 a 64
1247510	436505	65 a 76

Ref.	Código cazoleta	Medida
1247600	431201	4312 a 4338
1247601	434701	4347 a 4365

Ref.	Código husillo	Medida
1247700	430507	4305
1247701	430807	4307
1247702	431207	4312 a 4315
1247703	432007	4320 a 4338
1247704	434707	4347 a 4365

Se puede utilizar la barra de impacto como alargador.



Ref.	Código Barra	Balanza
1247800	4390	1,40

Ref.	Código Puente	Balanza
1247900	4392	1,50



Sirven para todas las pinzas.
Sin ningún tipo de adaptador.



4392

JUEGOS

Ref.	Código	Pinzas	Barra	Puente
1248000	43-10	4305 a 4330 Ø 5 a 37	+ 4390	-
1248001	43-22	4305 a 4338 Ø 5 a 46	+ 4390	+ 4392
1248002	43-30	4312 a 4338 Ø 12 a 46	+ 4390	-
1248003	43-42	4305 a 4365 Ø 5 a 76	+ 4390	+ 4392
1248004	43-11	4305 a 4330 Ø 5 a 37	-	+ 4392
1248005	43-31	4312 a 4338 Ø 12 a 46	-	+ 4392
1248006	43-52	4320 a 4365 Ø 20 a 76	4390	+ 4392





EXTRACTORES MECÁNICOS
9300 K - ESTUCHE PEQUEÑOS EXTRACTORES

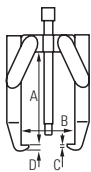

Ref.	Código	Se pueden componer	
1248100	9300 K	9300 - 9300 T - 9301 - 9301 T	1,8

4100 - SET BALL



Realiza la extracción agarrando entre las pistas exterior e interior del rodamiento.

Sus patas, en forma de bola, se introducen entre ambas pistas minimizando la resistencia y asegurando una rápida extracción.

Ref.	Código	Rodamiento ISO	Diámetro rodamiento	
1248200	4100	6004 a 6010 6200 a 6205 6300 a 6302 6004 a 6015	de 20 a 95 mm	0,9

INSTRUCCIONES DE USO

- Romper la jaula del rodamiento.
- Seleccionar el adaptador apropiado.
- Meter la bola con los planos paralelos a las pistas y girar en su interior 90°.

9084/9087 - JUEGOS

9084 / 4 TN KIT COMBI



El aprovechamiento de las piezas comunes economiza el juego.

Ref.	Código	Se pueden componer	
1248300	9084	1002 - 1102 - 1202 A - 5010	6,5
1248301		1304 - 1304 T - 1404 - 1404 T	

9087 / 7 TN KIT COMBI



Ref.	Código	Se pueden componer	
1248400	9087	1010 - 1110 - 1204 B - 1307 - 1307 L	14,5
1248401		1307 LT - 1407 - 1407 T - 2301 - 2302	





2000 - EXTRACTORES DE ESPÁRRAGOS

FORZA

Ref.	Código	Dim.	
		Ø mín.	Ø máx.
1248500	2001	10	16
1248501	2002	15	25



2100 - EXTRACTORES DE ESPÁRRAGOS

FORZA

Ref.	Código	Dim.	
		Ø mín.	Ø máx.
1248600	2101	8	19



2300 - EXTRACTORES DE ESPÁRRAGOS

FORZA

Ref.	Código	Dim.	
		Ø mín.	Ø máx.
1248700	2301	4,5	9,5
1248701	2302	8	19
1248702	2303	15	25



EXTRACTORES DE TORNILLOS ROTOS

5010 - JUEGO DE MACHOS ESTRIADOS

FORZA



Ref.	Código	Contenido	
1248800	5010	Juego en caja de plástico	0,27

5010C - JUEGO CON BROCAS Y GUÍAS

FORZA



Ref.	Código	Contenido	
1248900	5010C	Juego completo con 5 brocas y 10 guías. Exteriores.	0,60

5010N - JUEGO DE MACHOS EN ESPIRAL

FORZA



Ref.	Código	Contenido	
1249000	5010N	Juego de cuatro extractores en espiral	0,42

5010TR - JUEGO CON BROCAS Y GUÍAS

FORZA



Ref.	Código	Contenido	
1249100	5010TR	Juego completo con 4 extractores, 4 brocas y 8 guías	0,67



5681 - EXTRACTOR DE RÓTULAS

FORZA



Ref.	Código	Diámetro	Altura	
1249200	5681	18 a 22	50	0,7
1249201	5683	28 a 32	95	2,6

5681 - EXTRACTOR DE RÓTULAS

FORZA



Ref.	Código	Diámetro	Altura	Posiciones	
1249300	5691	20 a 24	36	2	1,5

5693 - EXTRACTOR DE RÓTULAS

FORZA



Ref.	Código	Diámetro	Altura	Posiciones	
1249400	5693	20 a 24	90	2	2,5

EXTRACTORES DE FILTRO DE ACEITE DE GARRAS DE ACERO TEMPLADAS

FORZA



Ref.	Código	Dimensiones Ø filtro
1249500	5000	de 55 a 72 mm
1249501	5001	de 68 a 110 mm
1249502	5001 G	de 110 a 142 mm

MAGNÉTICO

Ref.	Código	Dimensiones Ø filtro
1249600	5000 M	de 55 a 72 mm
1249601	5001 M	de 68 a 110 mm
1249602	5001 GM	de 110 a 142 mm

EXTRACTORES DE FILTRO DE ACEITE DE FLEJE

FORZA



Ref.	Código	Dimensiones Ø filtro
1249700	5002	de 65 a 110 mm
1249701	5003	de 110 a 155 mm

